

Article number: 2310306725ESD

Description: E+G Antistatic base for levelling elements
LV.A-125-24-M24x98-ESD-C

Measures

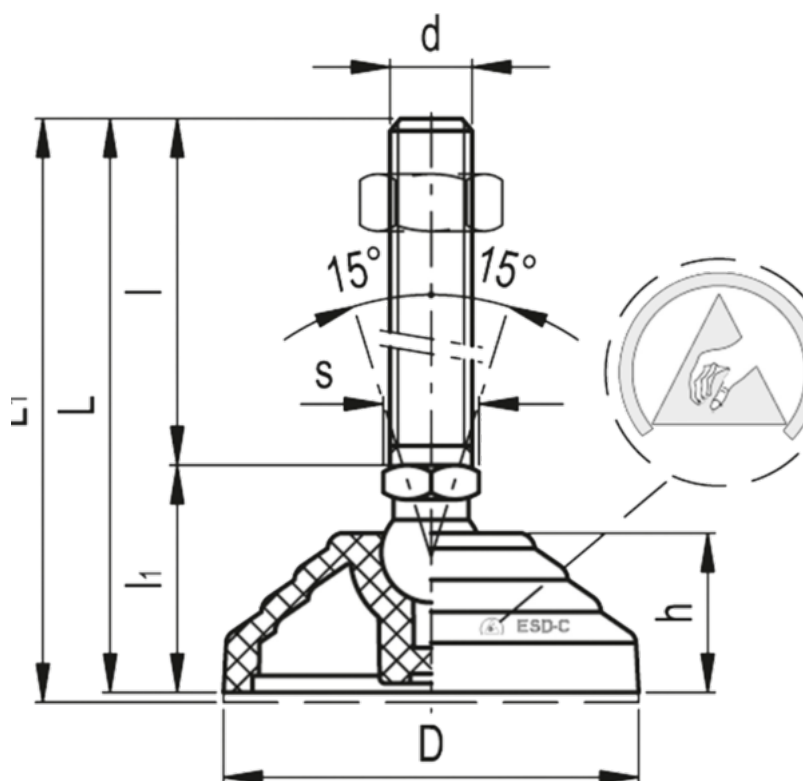

Articulation = 24
D = 125
d = M24
h = 46
l = -
l1 = -
L = 165
Max load = 28000

s = 24
Weight in (g) = 605